



TOOLSET

► TL-101-1

6 Functions features combo pliers content

Unlock & pre-lock



1_2 / Chain Pliers

For 10.11.12 speed master links and chains



3 / Bike Chain Hook



4 / Tire Levers

Tire lever not recommended for use on carbon rims



5 / Master Links Storage



Magnet

6 / Valve Core Tool



Storage Vault

P.A.T.E.D

► TL-102-1 8 Functions features tubeless repair kit

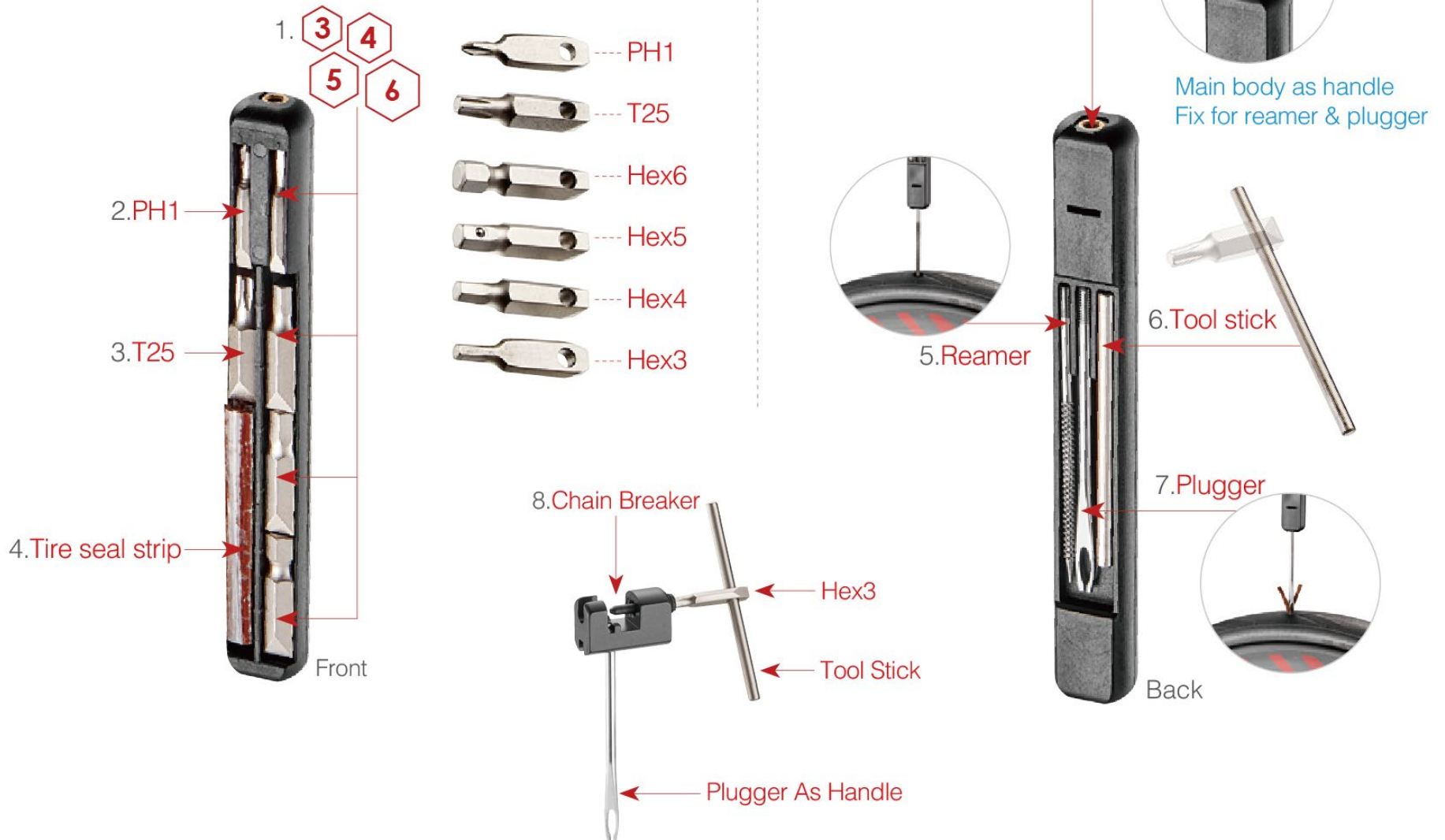

3 4 5 6
6功能板手組 6 PCS BITS

- 把手 Tool stick
- 十字 PH1
- 梅花25 T25
- 六角3 Hex3
- 六角4 Hex4
- 六角5 Hex5
- 六角6 Hex6

鏈條配件 LINKS & ACCESSORIES

- 快扣 Chain quick links
可自行到商店購買 (You may purchase it in the shop)
- 快扣拆卸 Chain Pliers
- 快扣存放槽 Master Links Storage
- 鏈條鉤 Bike Chain Hook
- 打鏈器 Chain Breaker

補胎和配件 PATCHING TIRE & ACCESSORIES

- Co2鋼瓶 Threaded CO2 cartridges
可自行到商店購買 (You may purchase it in the shop)
 - Co2氣瓶嘴(選配) Co2 Inflator (Option)
 - (S)打氣筒(選配) (S) Bicycle Pump (Option)
 - (L)打氣筒(選配) (L) Bicycle Pump (Option)
 - (L)打氣筒轉接頭(選配) (L) Bicycle Pump Adapter (Option)
- FOURERS 選配配件
FOURERS Option Accessories

輪框配件 RIM SET ACCESSORIES

- 補胎片專用膠 Glue
可自行到商店購買 (You may purchase it in the shop)
- 磨片 Grinder
- 補胎片 Patch
- 自黏式補胎片 Self-adhesive patch
- 銼刀 Reamer
- 補胎條 Tire seal strip
- 補胎條壓入器 Plugger As Handle

- 輻條扳手 Spoke wrench
- 氣心拆卸孔 Valve Core Tool
- 挖胎棒 Tire Lever
- 銅頭 Nipple
- 輻條 Spoke
可自行到商店購買 (You may purchase it in the shop)

22 Functions

建議在您旅行前從商店購買
SUGGEST BUY FROM SHOP BEFORE YOUR TRAVEL



輻條 Spoke

銅頭 Nipple

快扣 Chain quick links

補胎片專用膠 Glue

Co2鋼瓶 Threaded CO2 cartridges

TL-500 / 14 Functions

(TL-500-1+TL-101-1+TL-102-1)

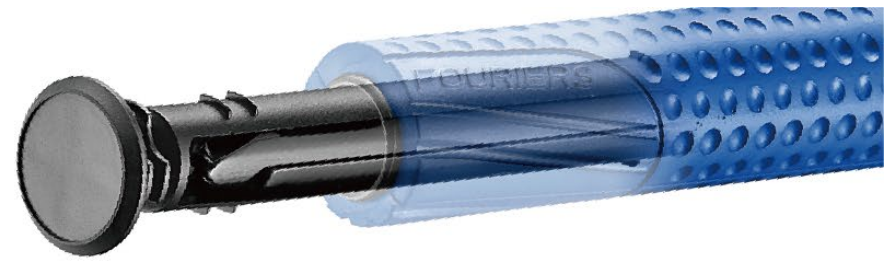

Front



Back



P.A.T.ED



TL-600 / 15 Functions

(TL-101+TL-102)



P.A.T.E.D



Compatible with the CO2 Cartridge or the ADP-CO2-A1-T (optional).

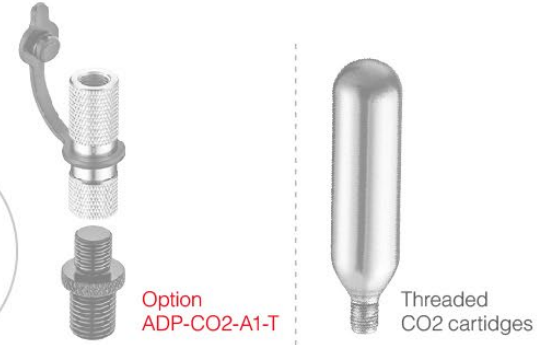

Front



Back



TL-700 / 15 Functions

(TL-101+TL-102+WB-UHD-22)



P.A.T.E.D



Option
ADP-CO2-A1-T



Threaded
CO2 cartridges

Compatible with the CO2 Cartridge or the
ADP-CO2-A1-T (optional).



Front



Back



TL-750 / 15 Functions

(TL-500-1+TL-101+TL-102+WB-UHD-22)



Compatible with the CO2 Cartridge or the ADP-CO2-A1-T (optional).

TL-800 / 17 Functions

(Bicycle Pump+TL-103+ADP-CO2-A1-T+ADP-CO2-A1-C+WB-UHD-22)



Compatible with the CO2 Cartridge or the
ADP-CO2-A1-T / ADP-CO2-A1-C.

ADP-CO2-A1-C



P.A.T.E.D



Front



Back



TL-105

Stainless steel plate nylon container

CONTENT: Spoke wrench x 1pcs
Patch x 12pcs
Tire seal strip 5 strip x 3pack
Self-adhesive patch x 12pcs
Grinder x 1pcs





F-STRAP

Quick and easy to carry repair kits when long distance riding.

VELCRO LENGTH: 58cm



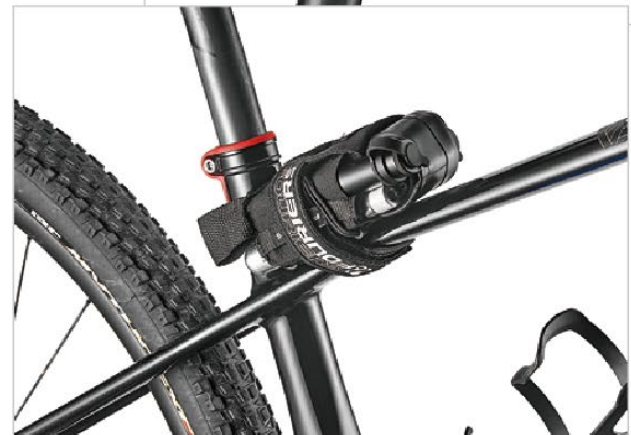

F-STRAP-BAG

Quick and easy to carry repair kits when long distance riding, include mounting bag to helpful for sorting kit.

VELCRO LENGTH: 58cm



SPAX-12X-M0-C2 PROMOTION

12mm axle with CNC cut to save weight and spiry helicoid cut to prevent axle stuck with dust and mud and prevent the axle stuck in the hub.



Allen key design at front head and rear end to make a longer life use.



Riveting workieces



禾諾企業有限公司
LAMINAR ENT. CO.,LTD.

台中市豐原區豐南街92巷167-3號
TEL:886-4-25391989 FAX:886-4-25391973
Email:paimacro@ms35.hinet.net

材料測試_試驗報告

- | | |
|-----------------------------|-------------------------------------|
| 1.公司名稱: 禾諾企業有限公司 | 8.試件名稱: sample |
| 2.操作者: Sam | 9.標點距離: 50.000mm |
| 3.試驗批號: SPAX 12X MO -Sampl1 | 10.試件斷面: 不規則 |
| 4.試驗日期: 2021年3月12日 | 11.試件斷面: 不規則 |
| 5.試驗溫度: 25C | 12.試件面積: 400.0000mm ² |
| 6.試驗型態: 拉力試驗 | 13.總能量: 18J |
| 7.試驗標準: 心軸拉力破壞 | 14.弦形係數: 148.852kgf/mm ² |
| | 15.備註: |

	荷重(kgf)	伸長(mm)	應力(kgf/mm ²)	應變(%)
最大	1828.9	1.82	4.572	3.64
斷裂	1111.7	1.86	2.779	3.72
降伏	0.0	0.00	0.000	0.00

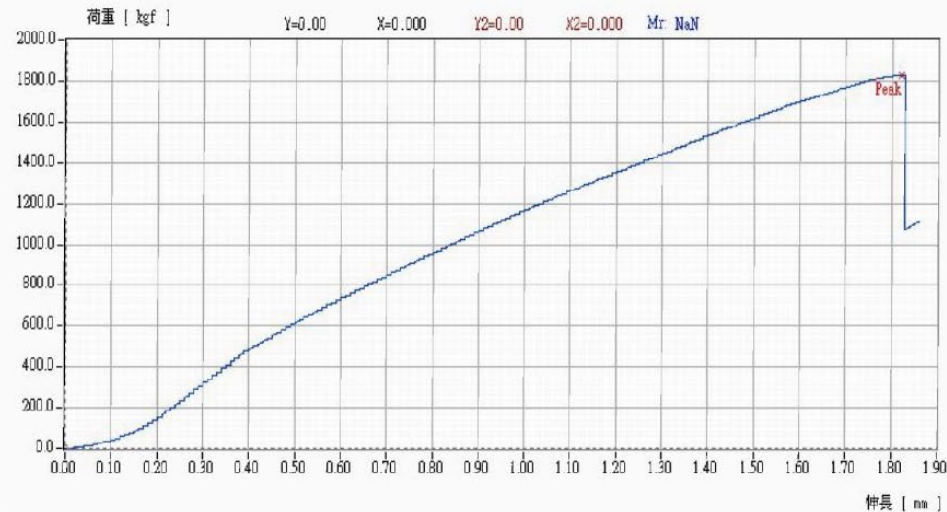

Click
Me



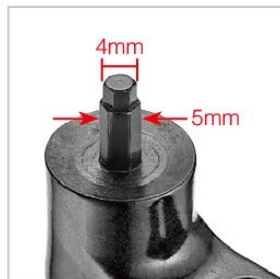

QR-TAK-12X/15X-C2

P.A.T. ED



QR-MF18-12X (C2) PROMOTION

SPAX-TL-12X PROMOTION



P.A.T. ED



CH-R1-MINI



CH-EX-FD



CH-ES-LD



CH-CM1



FITTING

Series



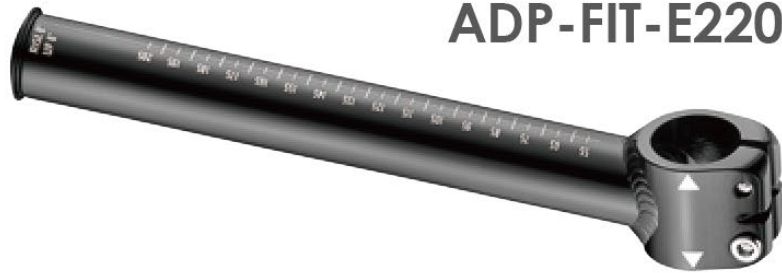

ADP-FIT-E220

Adjustable welding stem.

MATERIAL: AL6066

ANGLE: $\pm 8^\circ$

CLAMP HEIGHT: 50mm

C-C: 205mm

STEM TUBE SIZE: $\varnothing 28.6\text{m}$

Length adjustable 55mm~205mm

Only for fitting setting not for outdoor riding.



ADP-FIT-RHB



Allow you to find the most appropriate handlebar width swiftly and painlessly.

Ease your physical fatigue for long distance riding.

MATERIAL: AL6061

SPEC: 320~440mm

DROP: ± 125 mm

REACH: ± 70 mm

Only for fitting setting not for outdoor riding.

Find your perfect handlebar width swiftly.





ADP-FIT-SA

Use the **STEM ADJUSTER** to provide fitting service for the biker on his or her own bike to earn the right stem length (50mm~150mm) and angle (± 20 degrees) .

FORK STACK HIGH: $\varnothing 40\text{mm}$, $\varnothing 31.8\text{mm}$ with shim $\varnothing 28.6\text{mm}$

HANDLEBAR CLAMP: $\varnothing 35\text{mm}$ with shim $\varnothing 31.8\text{mm}$

LENGTH: 50 - 150mm

ANGLE: $\pm 25^\circ$



ADP-FIT-XYA



Stem slimension inspection platform.

MATERIAL: AL6061-T6

SPEC:

HANDLEBAR STEM: $\text{Ø}31.8 \times \text{Ø}34.9 \times (\text{H})50\text{mm} \times 1\text{pcs}$

SPACER: $\text{IDØ}28.6 \times \text{ODØ}34.2 \times (\text{H})3\text{mm} \times 2\text{pcs}$

$\text{IDØ}28.6 \times \text{ODØ}34.2 \times (\text{H})5\text{mm} \times 2\text{pcs}$

$\text{IDØ}28.6 \times \text{ODØ}34.2 \times (\text{H})10\text{mm} \times 1\text{pcs}$

$\text{IDØ}31.8 \times \text{ODØ}38.8 \times (\text{H})2.5\text{mm} \times 2\text{pcs}$

$\text{IDØ}31.8 \times \text{ODØ}38.8 \times (\text{H})5\text{mm} \times 2\text{pcs}$

$\text{IDØ}31.8 \times \text{ODØ}38.8 \times (\text{H})10\text{mm} \times 1\text{pcs}$

SHIM-CC-AL: $\text{IDØ}28.6 \times \text{ODØ}31.8 \times (\text{H})38\text{mm} \times 1\text{pcs}$

$\text{IDØ}31.8 \times \text{ODØ}34.9 \times (\text{H})58\text{mm} \times 1\text{pcs}$

WEIGHT: 2.515kg/set





ADP-FIT-CZ

Precision CNC machines fitting bike sizing cranks.

CRANK LENGTH: 145,150,155,160,165,167.5,170,
172.5,175,177.5,180mm

AXLE: 24mm / 30mm

MATERIAL: Crank: AL6061-T6
Axle: AL7075-T651

CHAINRING: Single 46T



CK-GRA



145

147.5

150

152.5

155

157.5

160

162.5

165

167.5

170

172.5

175mm



WATER BOTTLE & CAGE



WB-R1-20C



Quick link storage



Side-pull water bottle cage

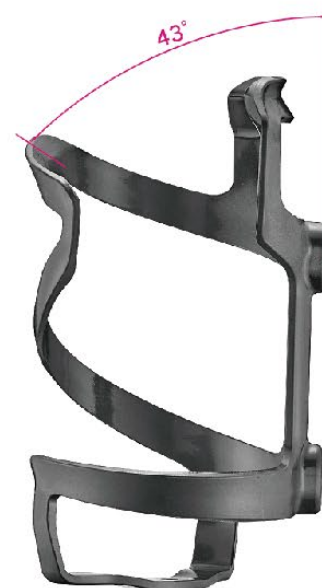
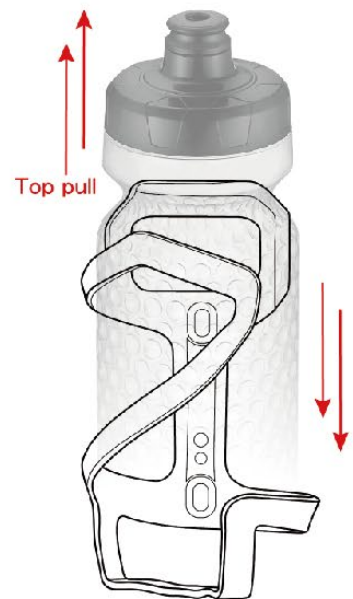
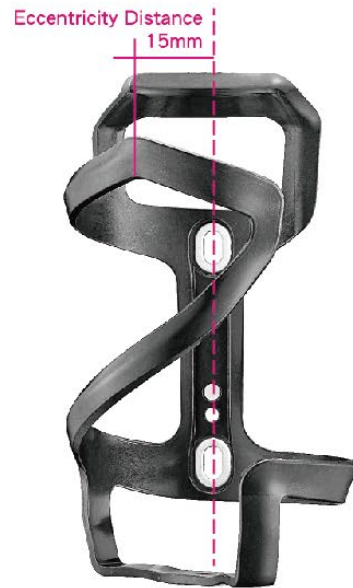

CL-CV OVER SIZE



P.A.T.ED WORLD WIDE

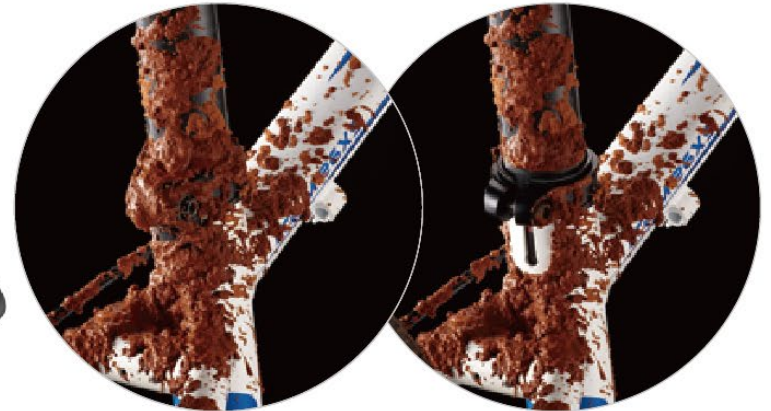

SPEC: Ø27.2 seatpost - Ø31.8 seattube / Ø31.6 seatpost - Ø34.9 seattube
Ø27.2 seatpost - Ø34.9 seattube / Ø30.9 seatpost - Ø34.9 seattube
Ø33.9 seatpost - Ø38.1 seattube / Ø34.9 seatpost - Ø38.6 seattube



TK-MG-CO

Top cap with full cover.

Material: AL-6061T6

COLOR: As order

WEIGHT: 9g

Custom logo design available



ADP-KIOX-TOP



ADP-KIOX-GRBAR-31.8 ADP-KIOX-GR-31.8 / 34.9



ADP-KIOX-BWP



ADP-KIOX-FP



ADP-KIOX-GR-MB-31.8 / 34.9



ADP-KIOX-FBE-BAR32/35

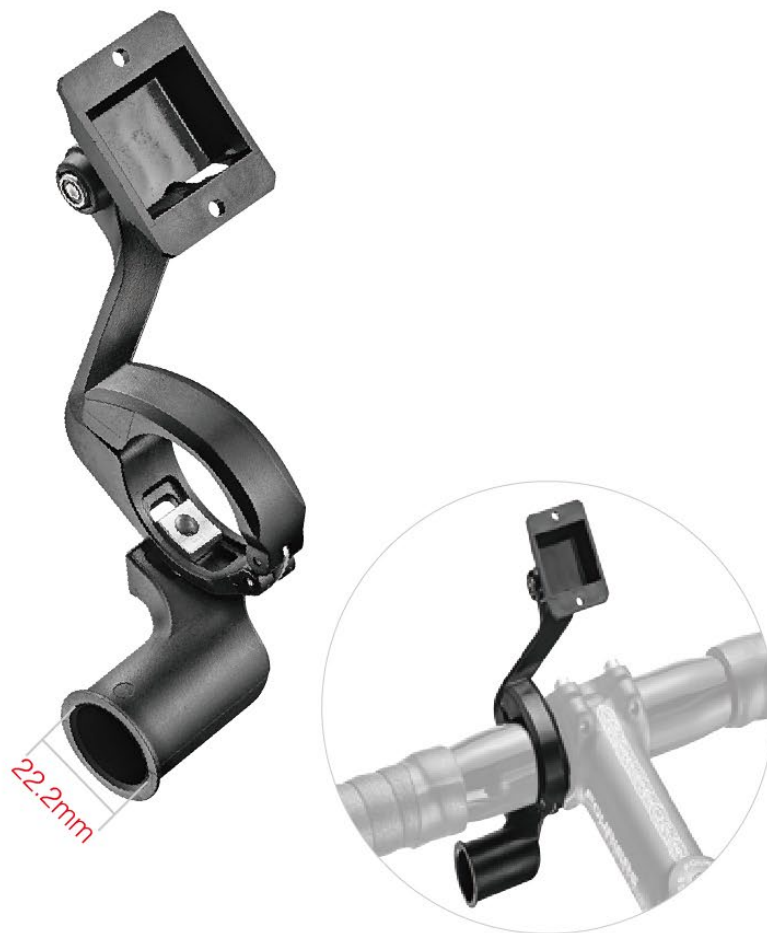

ADP-KIOX-MBE32 / 35



ADP-KIOX-FBE32 / 35



E-BIKE SYSTEM



TRSK-BSH-NW
TRSK-BSH-NWOF3
TRSK-BSH-NWOF6

For BOSCH® system Narrow Wide chainring.



TRSK-BSH
TRSK-BSH-OF3
TRSK-BSH-OF6

For BOSCH® system chainring.

Property	Specification
Remanence	>1.3T
Polarization	Towards Sensor
Dimensions	Thickness > 0.5 x Diameter (h > 0.5 d) Diameter > Thickness (d > h)
Volume*	$V = \pi \times h \times (d / 2)^2$ Depending

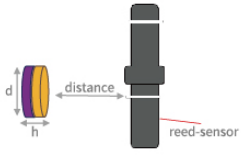
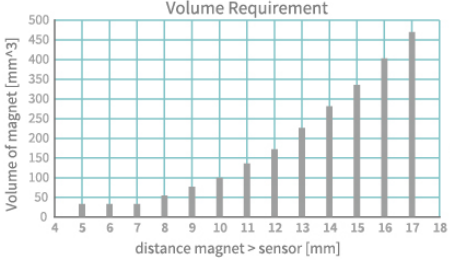

ADP-SHE8-P74S

For E-bike speed sensor adapter, can fix SHIMANO® SM-RTC60.

▶ 6-Bolt Magnet

Fix 6-hole internal disc

▶ 5-Bolt Magnet

Fix SM-RTC60

SHIMANO® SM-RTC60: 5-hole disc with 74mm pitch circle diameter.
SHIMANO® SG-C8061-8CD: 5-hole disc with 74mm pitch circle diameter.

▶ 4-Bolt Magnet

Fix Rohloff Spec



ADP-SHE8-RHMS

E-bike speed sensor adapter of rohloff speed hub E14.

▶ Center Lock Magnet

Fix SHIMANO® lock thru axle disc system

- ADP-SHE8-1S**
- ADP-SHE8-2S**
- ADP-SHE8-3S**
- ADP-SHE8-W56S/ADP-SHE8-W60S**



For E-bike speed sensor adapter.



ADP-SHE8-WS

Washer of SHIMANO® disc rotor.

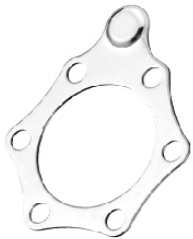

ADP-SHE8-HS

For E-bike speed sensor adapter.



ADP-M-SHE8-32CS ADP-M-SHE8-40CS

Lockring adapter for E-bike speed sensor.



ADP-SH2

SHIMANO® center-lock disc hub adp.
Stainless steel washer with alloy nut



ADP-SH1

SHIMANO® center-lock disc hub adp.
Stainless steel washer with alloy nut



ADP-SH1220

SHIMANO® center-lock 12 / 20mm thru-axle disc hub adapter.
With alloy lockring (M-SH3611)



ADP-DISC-SH-F

Center lock system / With alloy lockring.
Front 15mm boost hub adapter for 100mm transform to 110mm hub.



ADP-DISC-SH-R

Center lock system / With alloy lockring.
Rear 12mm boost hub adapter for 142mm transform to 148mm hub.



ADP-DISC-R6

Rear 12mm boost hub adapter for 142mm transform to 148mm hub.



ADP-DISC-F

Front 15mm boost hub adapter for 100mm transform to 110mm hub.



NZ-TUSH-F

The multi-vent valve allows users to pump up tyres quickly and also works with most the foam-inserted tubeless tyres.

MATERIAL: AL6061-T6 with NBR taper cone spacer

SPEC: Presta valve

LENGTH: 47, 52, 62, 72, 87, 107mm

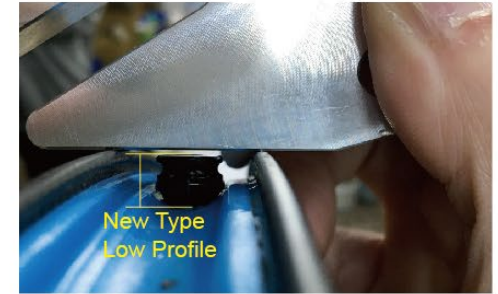
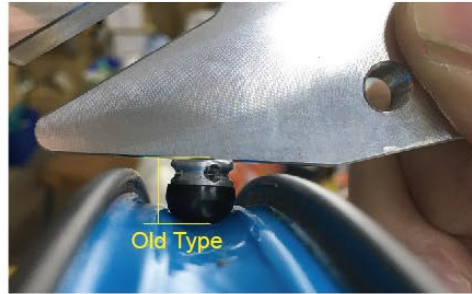

ADP-STEM

Steering tube extend.
For Ø28.6mm fork.

Adjust the height (mm)

	MIN	MAX
50	47.5	65.5
90	47.5	105.5
120	47.5	135.5