

Mr. control

2023

NEW ITEM

HIGH PERFORMANCE
FOR EVERYONE



1991-2023

WE ARE HERE FOR 30 YEARS MORE

- **2020 - 2023**
- Employees: From 60 to 120 people
- Production volume + 100%
- Machines Currently in service:
Swiss lathe, CNC Milling Machine (3 axle, 4 axle, 5 axle), 28 sets CNC lathe,
4 sets Turning & Milling Machine in the factory
- Subcontract factory over 100 sets CNC machine capacity



▲ 4-Axis Milling Machine

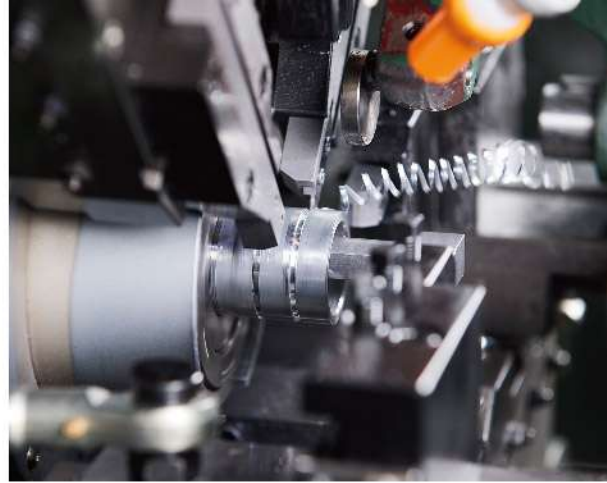

▲ Automatic Cam Lathe



▼ 3+2-Axis Machine



▼ Swiss Lathe

▼ CNC Turning Lathe

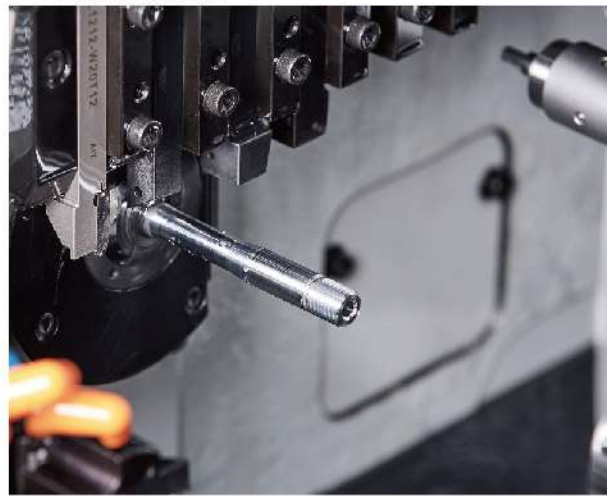

NEW
UDH-HANGER

Universal Derailleur Hanger.

MATERIAL: High Strength AL6066-T6/
Nylon12+Glass Fiber

COLOR: Black
WEIGHT: 27g



NEW
SPAX-UA-1-142(168mm)
SPAX-UA-1-148(176mm)

Thru axle with UDH hanger set.

MATERIAL: Axle/High Strength AL6066-T6
Hanger/ High Strength AL6066-T6/ Nylon12+Glass Fiber
Custom length thread design available.



Main body Alloy co-molded with Nylon destructive test.
"Passed the torque test of 40N.m"



NEW
CL-50WB

Water bottle cage adapter for Ø31.8 clamp.
Rotate 90 degrees available.

MATERIAL: AL6061-T6
SPEC: Ø31.8 mm



For handlebar.



For seat post.



NEW
WB-EXT-M

Bottle cage adapter.
Used to change the position of the water bottle cage.
Adjustable range 46mm.

MATERIAL: AL6061-T6

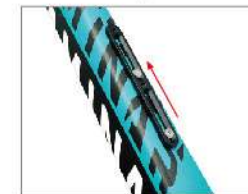

NEW
CH-G23-MED2

For MTB 1X system drivetrain with bash guard.

MATERIAL: AL6061-T6/ Nylon

SPEC: ISCG 05

TEETH: 28-34T

COLOR: As Order



NEW
CH-CLD

MATERIAL: AL6061-T6

SPEC: Clamp Ø34.9,
Ø31.8, Ø28.6 mm

COLOR: Black



NEW
CH-DLG

MATERIAL: AL6061-T6

SPEC: ISCG 05

TEETH: 28-34T

COLOR: Black



NEW
CH-BB-MU

BB mount tensioner.

MATERIAL: AL6061-T6

SPEC: Customization

COLOR: Black



NEW
AR-28.6-H

Alloy spacer for Ø28.6 fork.
Carbon fiber steering tube please notify.

MATERIAL: AL6061-T6
SPEC: ID 28.8±0.2 x OD Ø34mm / ID 28.8±0.2 x OD Ø36mm
H: OD Ø34- 50, 100, 110, 120, 130, 140, 150, 160, 180, 200 mm
OD Ø36- 50, 100, 110, 120, 130, 140, 150, 175, 200 mm
COLOR: Sand blast black, silver
Black, Silver
As Order

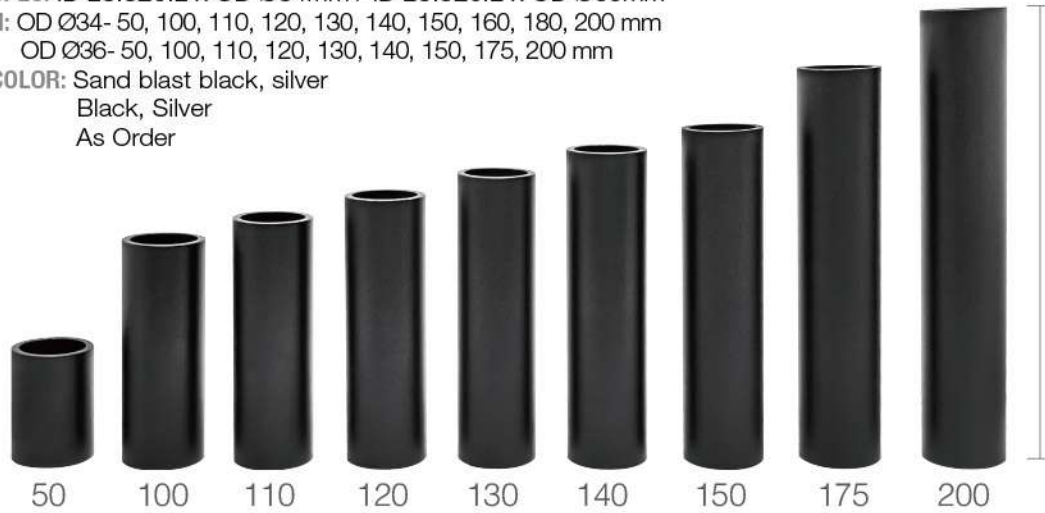

NEW
ADP-BT-S

Holder for SRAM® AXS/ ETAP battery.

MATERIAL: Nylon66
COLOR: Black



NEW
ADP-3RL-2X32

Double clamp for Ø31.8 extension bar,
create extra space for bikepacking gear.

Material: 6061-T6
Spec: Clamp Ø31.8
TUBE Ø31.8 x 200L



Removeable end cap.
Tube inside for extrastorage space.

SPAX-12X-M0-C2 PROMOTION

12mm axle with CNC cut to save weight and spiry helicoid cut to prevent axle stuck with dust and mud and prevent the axle stuck in the hub.

Patent Number: M613599

Material: AL 6066-T6
Custom length available.



Allen key design at front head and rear end to make a longer life use.



Riveting workieces



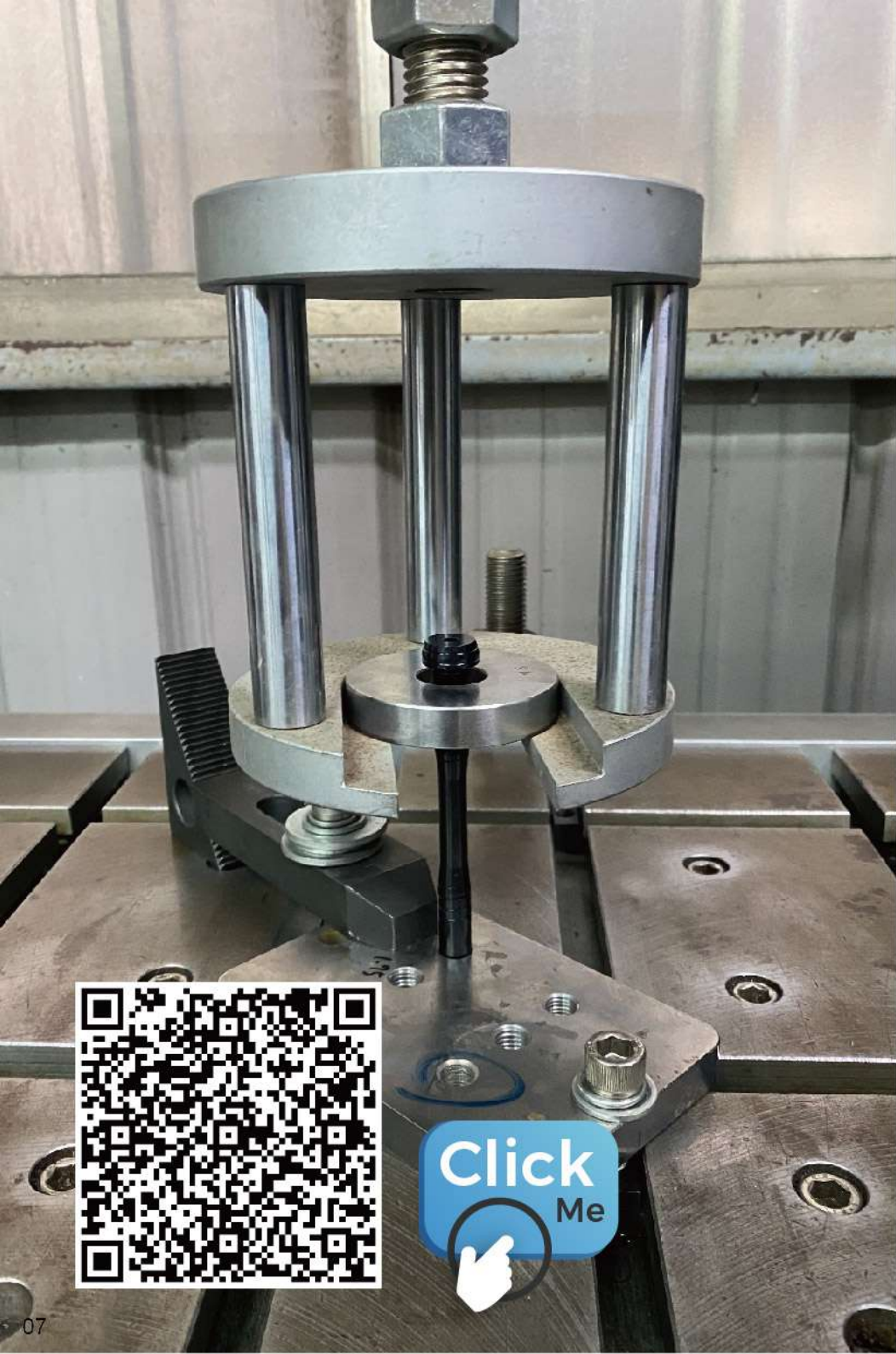

禾詰企業有限公司
LAMINAR ENT. CO.,LTD.

台中市豐原區豐南街92巷167-3號
TEL:886-4-25391989 FAX:886-4-25391973
Email:paimaero@ms35.hinet.net

材料測試_試驗報告

- | | |
|----------------------------|------------------------------------|
| 1.公司名稱：禾詰企業有限公司 | 8.試件名稱：sample |
| 2.操作者：Sam | 9.標點距離：50.000mm |
| 3.試驗批號：SPAX 12X MO -Sampl1 | 10.試件斷面：不規則 |
| 4.試驗日期：2021年3月12日 | 11.試件斷面：不規則 |
| 5.試驗溫度：25C | 12.試件面積：400.0000mm ² |
| 6.試驗型態：拉力試驗 | 13.總能量：18J |
| 7.試驗標準：心軸拉力破壞 | 14.弦形係數：148.852kgf/mm ² |
| | 15.備註： |

	荷重(kgf)	伸長(mm)	應力(kgf/mm ²)	應變(%)
最大	1828.9	1.82	4.572	3.64
斷裂	1111.7	1.86	2.779	3.72
降伏	0.0	0.00	0.000	0.00

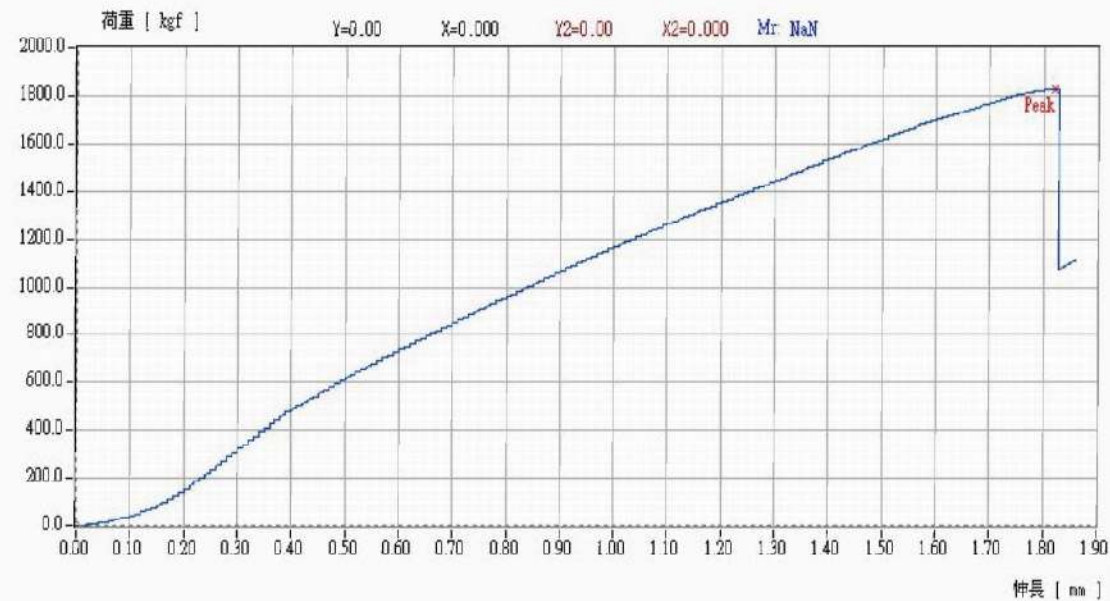

QR-TAK-12X/15X-C2

Material: Axle/ 6066-T6
Lever/ Carbon injection



P.A.T. ED

PROMOTION

QR-MF18-12X (C2)

Material: Axle/ 6066-T6
Lever/ Carbon injection



PROMOTION SPAX-TL-12X



P.A.T. ED



NEW

SPAX-12X-R2R

Protects the dropout from side impacts,
Strengthens interface between derailleur
and frame, with Custom length thru axle.

MATERIAL: AL6061-T6
COLOR: Sand blast black
SPEC: Custom length thread design available



NEW
AXLE-CUT-V

Tool for Axle length cutting.

MATERIAL: AL7075-T6
Stainless 304

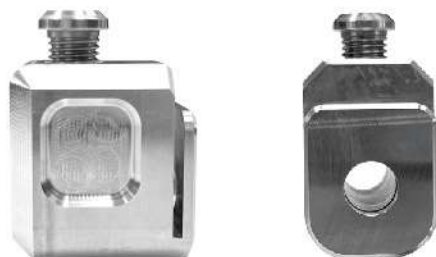

QR-SM-TAR

For rear \varnothing 12mm thru axle.
Include width adjuster: 142, 148, 150mm.

MATERIAL: AL6061-T6
WEIGHT: 91g/set (with adapter)



QR-SM-PLR-142E/ 148E / 150E

Handy chain tension device for travelling.
For rear \varnothing 12mm thru axle frame.

MATERIAL: Plastic
SPEC: Width 142 / 148 / 150mm
WEIGHT: 46g/pcs (142E)



QR-SM-TAF012 / TAF015 / TAF0151 / TAF020

For fork \varnothing 12 x 100 thru axle
 \varnothing 15 x 100 thru axle
 \varnothing 15 x 110 thru axle
 \varnothing 20 x 110 thru axle

MATERIAL: AL6061-T6
WEIGHT: 33g/pcs (TAF015)
44g/pcs (TAF020)



CH-R1-MINI



Material: Long fibers carbon injection

CH-ES-LD



CH-EX-FD



CH-CM1



NEW

CH-BOSCX-MED2

CH-BOSCX-MED

CH-BOSCX-MINI

For Bosch CX GN5 chain guide

MATERIAL: AL 6061T6

SPEC: Bosch CX GN5

RANGE: 32T-38T

COLOR: As Order

OPTION: Spacer thickness



CH-BOSCX-MED2



CH-BOSCX-MED



CH-BOSCX-MINI

ADP-KIOX-MBE32 / 35



ADP-KIOX-FBE-BAR32 / 35



22.2mm

ADP-KIOX-FBE32 / 35



ADP-KIOX-GRBAR-32 / 35
ADP-KIOX-GR-32 / 35



Ø31.8
or
Ø35



22.2mm

ADP-KIOX-BWP



Ø31.8



ADP-KIOX-FP



Ø31.8



ADP-KIOX-GR-MB-32 / 35



ADP-KIOX-TOP



E-BIKE SYSTEM



TRSK-BSH-NW
TRSK-BSH-NWOF3
TRSK-BSH-NWOF6

For BOSCH® system Narrow Wide chainring.



TRSK-BSH
TRSK-BSH-OF3
TRSK-BSH-OF6

For BOSCH® system chainring.

Property	Specification
Remanence	>1.3T
Polarization	Towards Sensor
Dimensions	Thickness > 0.5 x Diameter (h > 0.5d) Diameter > Thickness(d > h)
Volume*	$V = \pi \times h \times (d / 2)^2$ Depending

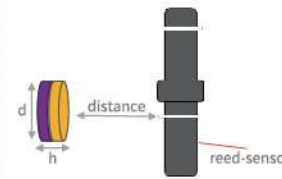
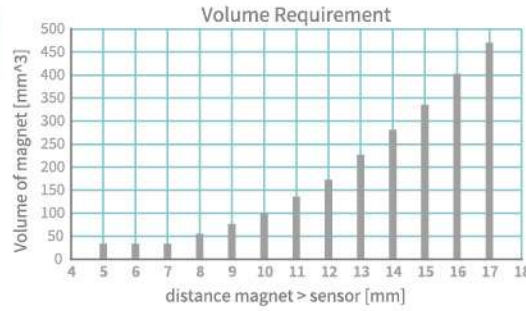

ADP-SHE8-P74S
For E-bike speed sensor adapter, can fix SHIMANO® SM-RTC60.



ADP-SHE8-RHMS

E-bike speed sensor adapter of rohloff speed hub E14.



ADP-SHE8-1S
ADP-SHE8-2S
ADP-SHE8-3S
ADP-SHE8-W56S/ADP-SHE8-W60S

For E-bike speed sensor adapter.

► 6-Bolt Magnet

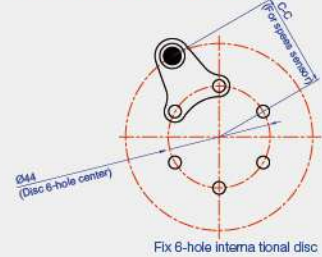

► 5-Bolt Magnet

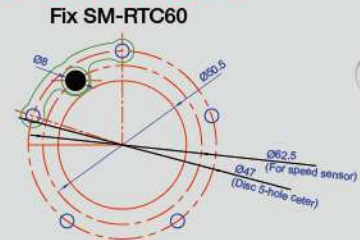

SHIMANO® SM-RTC60:
5-hole disc with 74mm pitch circle diameter.
SHIMANO® SG-C8061-8CD:
5-hole disc with 74mm pitch circle diameter.

► 4-Bolt Magnet

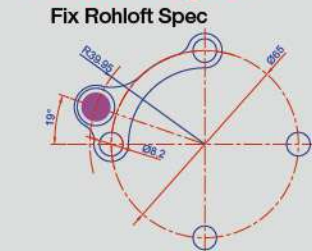

ADP-SHE8-RHMS

► Center Lock Magnet

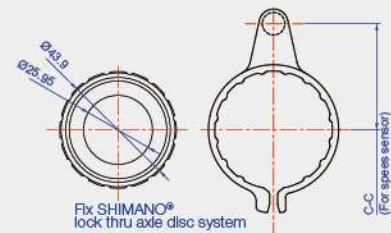



ADP-SHE8-WS

Washer of SHIMANO® disc rotor.

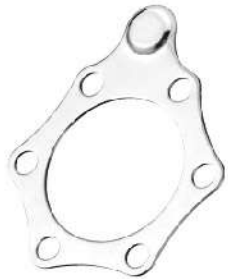

ADP-SHE8-HS

For E-bike speed sensor adapter.



ADP-M-SHE8-32CS ADP-M-SHE8-40CS

Lockring adapter for E-bike speed sensor.



ADP-SH2

SHIMANO® center-lock disc hub adp.
Stainless steel washer with alloy nut



ADP-SH1

SHIMANO® center-lock disc hub adp.
Stainless steel washer with alloy nut



ADP-SH1220

SHIMANO® center-lock 12 / 20mm thru-axle disc hub adapter.
With alloy lockring (M-SH3611)



ADP-DISC-SH-F

Center lock system / With alloy lockring.
Front 15mm boost hub adapter for 100mm transform to 110mm hub.



ADP-DISC-SH-R

Center lock system / With alloy lockring.
Rear 12mm boost hub adapter for 142mm transform to 148mm hub.



ADP-DISC-R6

Rear 12mm boost hub adapter for 142mm transform to 148mm hub.



ADP-DISC-F

CL-CV OVER SIZE



P.A.T.ED WORLD WIDE



SPEC: Ø27.2 seatpost - Ø31.8 seattube / Ø31.6 seatpost - Ø34.9 seattube
Ø27.2 seatpost - Ø34.9 seattube / Ø30.9 seatpost - Ø34.9 seattube
Ø33.9 seatpost - Ø38.1 seattube / Ø34.9 seatpost - Ø38.6 seattube



TK-MG-CO

Top cap with full cover.

Material: AL-6061T6

COLOR: As order

WEIGHT: 9g

Custom logo design available



TK-BEERA

With TK-001S

MATERIAL: AL6061-T6 CNC finished
COLOR: As order
WEIGHT: 23g (W/O star nut)
Size: 1-1/8"



TK-TD01

MATERIAL: AL6061-T6
WEIGHT: 13g/pcs (W/O star nut)
SIZE: 1-1/8"
COLOR: Sand blast anodize with star nut
OPTION: AL7075-T73 screw
Stainless screw

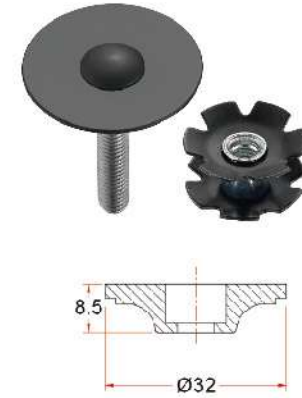

TK-TD18

MATERIAL: AL6061-T6
WEIGHT: 13.3g/pcs (W/O star nut)
SIZE: 1-1/8"
COLOR: Sand blast anodize with star nut
OPTION: AL7075-T73 screw



TK-TD12-E

MATERIAL: AL6061-T6
WEIGHT: 16.5g/pcs (W/O star nut)
SIZE: 1-1/8"
COLOR: Sand blast anodize
Stainless screw
OPTION: AL7075-T73 screw



TK-TD-C

MATERIAL: Carbon
WEIGHT: 11.5g/pcs (W/O star nut)
SIZE: 1-1/8"
With star nut



TK-001D

MATERIAL: AL6061-T6
WEIGHT: 14.5g/pcs (W/O star nut)
SIZE: 1", 1-1/8"
OPTION: 1. Stainless screw
2. Star nut



LONG CARBON FIBER SPACER

Carbon Long fibers with nylon Injection material, can use and Create carbon high texture lightweight products.
For more details please contact our engineers.

MATERIAL: Long carbon fiber-reinforced PA12 resin
COLOR: UD Surface, UD with painting
Custom design available



UD Surface

AC-25.4-H / AC-28.6-H AC-31.8-H / AC-38.1-H

Carbon spacer.

Spec: AC-25.4-H (ID $\varnothing 25.6 \pm 0.2$ x OD $\varnothing 31.5$)
AC-28.6-H (ID $\varnothing 28.8 \pm 0.2$ x OD $\varnothing 34$)
AC-31.8-H (ID $\varnothing 32.0 \pm 0.2$ x OD $\varnothing 38.8$)
AC-38.1-H (ID $\varnothing 38.3 \pm 0.2$ x OD $\varnothing 45.2$)

H: As Order
Color: 3K, UD



ACE-28.6-H ACE-31.8-H

Carbon spacer.

P.A.T ED
Spec: ACE-28.6-H (ID $\varnothing 28.8$ x OD $\varnothing 34$)
ACE-31.8-H (ID $\varnothing 32.0$ x OD $\varnothing 38.8$)

H: As Order
Color: 3K, UD



AR-25.4-H / AR-28.6-H AR-31.8-H / AR-38.1-H

Alloy spacer.

Spec: AR-25.4-H (ID $\varnothing 25.6 \pm 0.2$ x OD $\varnothing 32$)
AR-28.6-H (ID $\varnothing 28.8 \pm 0.2$ x OD $\varnothing 32.5$,
 $\varnothing 33$, $\varnothing 34$, $\varnothing 35$, $\varnothing 36$)
AR-31.8-H (ID $\varnothing 32.0 \pm 0.2$ x OD $\varnothing 38.8$)
AR-38.1-H (ID $\varnothing 38.3 \pm 0.2$ x OD $\varnothing 44$)

H: As Order
Color: As Order



AE-28.6-H

Alloy spacer.

P.A.T ED
Spec: AE-28.6-H (ID $\varnothing 28.8 \pm 0.2$ x OD $\varnothing 34$)
H: As Order
Color: As Order
OPTION: $\varnothing 35$ or $\varnothing 36$



NEW
CL-BCV-45

QR-type for over size seat clamp with dust and water-proof cover.

MATERIAL: AL 6061-T6

SPEC: Ø34.9m/m seat post - Ø45m/m seat tube



NEW
SSP-AX-ROLLER KIT

MATERIAL: AL 6061T6 CAGE/AL7075 T651 PULLEY

SPEC: SRAM AXP derailleur system

COLOR: As Order

OPTION: Ceramics ball bearing

WEIGHT: 67g



ADP-STEM

Steering tube extend.
For Ø28.6mm fork.

Adjust the height (mm)

	MIN	MAX
50	47.5	65.5
90	47.5	105.5
120	47.5	135.5



NEW
ADP-3RL

Double alloy clamp with length 200m/m tube.
Adjustable clamp spacing.

MATERIAL: AL6061-T6

SPEC: Ø31.8mm

TUBE LENGTH: 200L

WEIGHT: 43g/ set

COLOR: As Order





ADP-ORG26-35



ADP-ORG26-35-A

NEW
ADP-ORG26-35/ ADP-ORG26-35-A

Create extra space for handlebar.
 Double clamp With Carbon tube Ø26mm.

MATERIAL: AL6061 clamp
 ADP-ORG26-35: 3K CARBON tube
 ADP-ORG26-35-A: AL6061 tube
SPEC: Ø35mm
W: 46mm/ 59mm



AVAILABLE IN DIFFERENT CYCLING COMPUTER AND CAMERA / LIGHT MOUNT

Interchangeable trays:



GM1
 (GARMIN Edge®)



Mio2
 (MIO® Cyclo™)



BTN3
 (Bryton Rider™)



GAT5
 (GIANT NEOSTRACK®)



WHO6
 (WAHOO ELEMNT®)



GPO7
 (GoPro®)



NEW
GMX-MY23

Computer mount for integrated bar stem.
 Main arm angle adjustable.

MATERIAL: AL6061
WEIGHT: 46g/ set

(Not available in Japan)



NEW
AC-MTB35

Clamping type for MTB and cyclocross cycling computer mount.
 Allow riders place computer above the stem.

MATERIAL: AL6061
SPEC: Clamp Ø35mm with SHIM Ø31.8mm
WEIGHT: 39g/ set

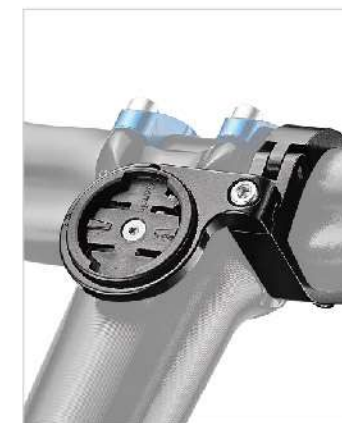

WB-R1-20C



Extra space for quick-link.



Easy to access bottle
sideward or upward.

Eccentricity Distance
15mm

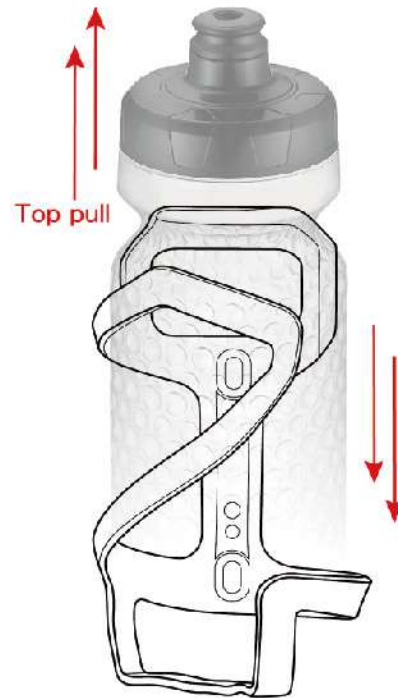

43°





DESIGN FOR DI2 CABLE HOLE

The inner cable of Di2 is getting popular, so Mr Control make change for all types of road bike handlebar, we drill the hole for Di2 inner cable to make the handlebar look more clean.

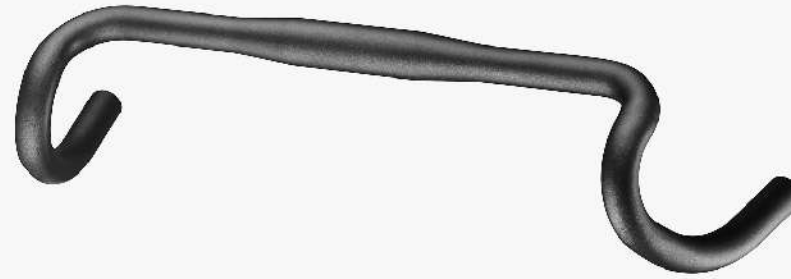

NEW HB-RBA-0209

MATERIAL: AL6061-T6
SPEC: Ø31.8 x W360mm / 380mm / 400mm / 420mm/ 440mm (C-C)
INWARD: 10degrees
FLARE: 10degrees
DROP: 115mm
REACH: 75mm
BAR TYPE: Compact bend
WEIGHT: 297g/pcs±10g

Innovation version

HB-RBA-0209

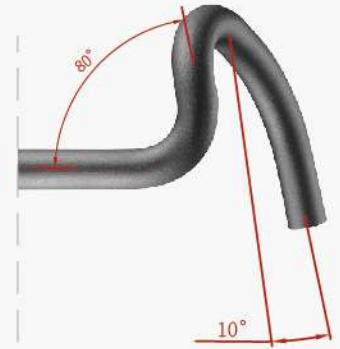

Current type

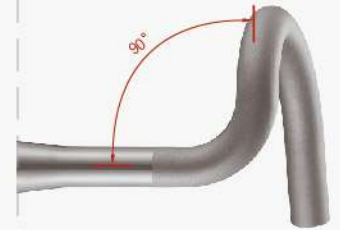

NEW WB-G301 / WB-G302-E

WB-G301: Pressure valve cap
WB-G302-E: Standard valve cap

MATERIAL: P.P
VOLUME: 600cc
WEIGHT: 54g/pcs (WB-G302-E)
COLOR: Black, Red, Blue, Apple Green, Orange, Purple, Pink, White, Transparent Black, Transparent, Yellow, Light Green, Sky Blue, Gold, Gray, Grass, Green, Prussian Blue, Lavender, Violet, Rose, Azure



NEW WB-G701 / WB-G702

WB-G701: Pressure valve cap
WB-G702: Standard valve cap

MATERIAL: P.P
VOLUME: 750cc
WEIGHT: 60g/pcs (WB-G702)
COLOR: Transparent Black



We offer stem extrusion material data Your stem design we process it (CNC) as you design.



WE MAKE STEM (CNC)



► Case Example

SM-1396_Project

MATERIAL: 6061-T6
LENGTH: C-C : 35m/m
SPEC: Steerer tube Ø28.6
Bar Bore Ø31.8



► Case Example

SM-1404_Project

MATERIAL: 6061-T6
LENGTH: C-C : 50m/m
SPEC: Steerer tube Ø28.6
Bar Bore Ø31.8





NEW
NZ-TUSH-F

The multi-vent valve allows users to pump up tyres quickly and also works with most the foam-inserted tubeless tyres.

MATERIAL: AL6061-T6 with NBR taper cone spacer

SPEC: Presta valve

LENGTH: 47, 52, 62, 72, 87, 107mm



NEW
SHIM-1012

MATERIAL: AL6061-T6

- SPEC:**
- OD Ø30.0 x ID Ø27.2 x (H)100mm
 - OD Ø30.2 x ID Ø27.2 x (H)100mm
 - OD Ø30.6 x ID Ø27.2 x (H)100mm
 - OD Ø30.9 x ID Ø27.2 x (H)100mm
 - OD Ø31.6 x ID Ø27.2 x (H)100mm
 - OD Ø33.9 x ID Ø30.9 x (H)110mm
 - OD Ø34.9 x ID Ø30.9 x (H)110mm
 - OD Ø33.9 x ID Ø31.6 x (H)110mm
 - OD Ø34.9 x ID Ø31.6 x (H)110mm
 - OD Ø40.0 x ID Ø33.9 x (H)120mm
 - OD Ø40.0 x ID Ø34.9 x (H)120mm

COLOR: As Order

Customized service design available.



NEW
SPA-35A

MATERIAL: 3D forged AL6066-T6

SPEC: Ø34.9

LENGTH: 450mm/ 600mm/ 700mm

OFFSET: 20mm

WEIGHT: 626g (450mm)



NEW

RACK-RCF-TA120

RACK-RCF-D120

Combine high-strength aluminium alloy rack and carbon fiber support frame. Moreover, it offers customized axle and mix two locking systems. It's the best choice for long distance cycling.

MATERIAL: Rack/ AL-6061 T6

Support Frame/ UD Carbon fiber &
AL-6061 T6 dropout

Thru Axle/ AL-6066 T6

Seat Clamp/ AL-6061 T6

SPEC: Axle length range - 160-170mm

Thread - M12 x 1.0/ M12 x 1.5/ M12 x 1.75

With ID 12 x 2mm/ 6mm/ 12mm

ID 10 x 2mm/ 4mm/ 6mm/ 10mm spacer.

Thru axle and clamp custom design available.



RACK-RCF-TA120



RACK-RCF-D120



CL-FR

SPEC: Ø28.6, Ø29.8,
Ø31.8, Ø34.9
H: 13.5mm



RACK-RCF-TA



RACK-RCF-D

Compatible with RACKTIME SNAPIT 2.0



NEW

TL-BB-EXT56
TL-BB-EXT50
TL-BB-EXT48
TL-BB-EXT43

MATERIAL: AL7075
COLOR: EXT56 Silver/ EXT50 Gold/ EXT48 Green/ EXT43 Gray
WEIGHT: EXT56 109g/ EXT50 82g/ EXT48 91g/ EXT43 66g



TL-BB-EXT56



TL-BB-EXT48



TL-BB-EXT50



TL-BB-EXT43

NEW

TL-BB-AXLE 2224
TL-BB-AXLE 2829
TL-BB-AXLE 2830

MATERIAL: AL6061-T6
COLOR: AXLE2224 Blue
AXLE2224 Black
AXLE2224 Red
WEIGHT: AXLE2224 59g
AXLE2224 120g
AXLE2224 126g



TL-BB-AXLE 2224



TL-BB-AXLE 2829



TL-BB-AXLE 2830

NEW

TL-BB-SET

The **BOTTOM BRACKET TOOL** is made by high precision CNC machine to provide better contact area and stability of operation. It can suitable for different specifications of BB and prevent tool slippage during use.

MATERIAL: AL7075/ AL6061-T6



TL-BB-EXT56



TL-BB-EXT48



TL-BB-AXLE 2224



TL-BB-AXLE 2829



TL-BB-EXT50



TL-BB-EXT43



TL-BB-AXLE 2830





NEW
WB-ATG-02

Air Tag holder that mount on the bike frame water bottle attachment point, and zip tip under the bike saddle rail.

MATERIAL: Nylon66

COLOR: Black

WEIGHT: 23g/pcs (With bolt)

Air Tag not included



NEW
TK-ATG01

Top cap with Air Tag holder, special locking tool include.

MATERIAL: Top cap: AL6061

Tool: Nylon

WEIGHT: 28g/ set

Air Tag not included



NEW
PU-8703-T22

The function of protector is to provide the best Friction resistance and protection for the frame, it keeps your frame new and clean.

MATERIAL: PVC

Spec: Top tube protection x1
Down tube protection x1
Chainstay protection x2
Frame or other protection x6

H: 0.4mm

COLOR: Matte transparent

WEIGHT: 31g

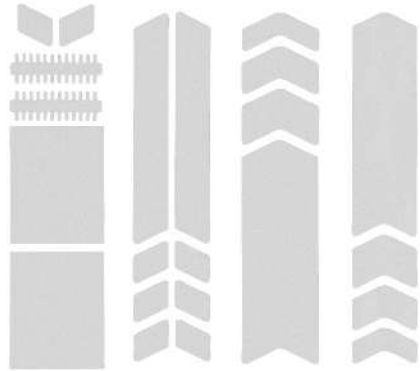

NEW
PU-9000-T22

The function of protector is to provide the best Friction resistance and protection for the frame, it keeps your frame new and clean.

MATERIAL: PVC

Spec: Top tube protection x1
Down tube protection x1
Chainstay protection x2
Frame or other protection x6

H: 0.25mm

COLOR: Transparent

WEIGHT: 29g



RS-MINI BAR

Create an additional hand position on the handlebar. Minimizes hand numbness, carpal and ulnar issues.

MATERIAL: Nylon

WEIGHT: 17.8g/set



NEW
ADP-FA-P16

For flat mount fork adapter to post mount caliper.

MATERIAL: AL 6061-T6

Spec: For 160m/m rotor

WEIGHT: 42g



NEW
ADP-RFA-P14

For flat mount frame adapter to post mount caliper.

MATERIAL: AL 6061-T6

Spec: For 140m/m rotor

WEIGHT: 16g



NEW
ADP-RFA-P16

For flat mount frame adapter to post mount caliper.

MATERIAL: AL 6061-T6

Spec: For 160m/m rotor

WEIGHT: 23g



NEW
ADP-RFA-P18

For flat mount frame adapter to post mount caliper.

MATERIAL: AL 6061-T6

Spec: For 180m/m rotor

WEIGHT: 26g

NEW

CL-ISPEC-2

SHIMANO® SL-RS700 I-SPEC-2 flat bar shift lever to clamp type.

MATERIAL: AL6061-T6
SPEC: I-SPEC-2
COLOR: Sand blast black



EV-CLAMP-21

Shifter (shift lever) I-SPEC-EV mount.

MATERIAL: AL6061-T6
Compatibility handlebar: 22.2mm
Compatibility shift lever: SHIMANO®
WEIGHT: 25g



NEW

ADP-EVMX22

Adapter for SRAM disc brake lever to SHIMANO shift lever with screw and nut.

MATERIAL: Forged AL 6061T6
SPEC: SRAM MMX system to SHIMANO® I-SPEC-EV system
WEIGHT: 16g/ set
COLOR: Sand blast black



ADP-ISPEC-EV

SHIMANO® disc brake lever can fix SRAM® shift lever. With special screw and nut.

MATERIAL: AL6061 -T6
SPEC: I-SPEC-EV



ADP-ISPEC-EV-21

SHIMANO® disc brake lever can fix SRAM® shift lever. With special screw and nut. Left & right same angle.

MATERIAL: AL6061 -T6
SPEC: I-SPEC-EV
WEIGHT: 15g/ set



▶ TL-101-1

6 Functions features combo pliers content

Unlock & pre-lock



1_2 / Chain Pliers

For 10.11.12 speed master links and chains

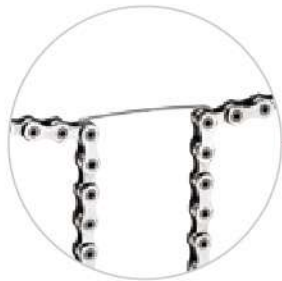

3 / Bike Chain Hook



4 / Tire Levers

Tire lever not recommended for use on carbon rims



5 / Master Links Storage



Magnet

6 / Valve Core Tool



Storage Vault

P.A.T.E.D

► TL-102-1

8 Functions features tubeless repair kit

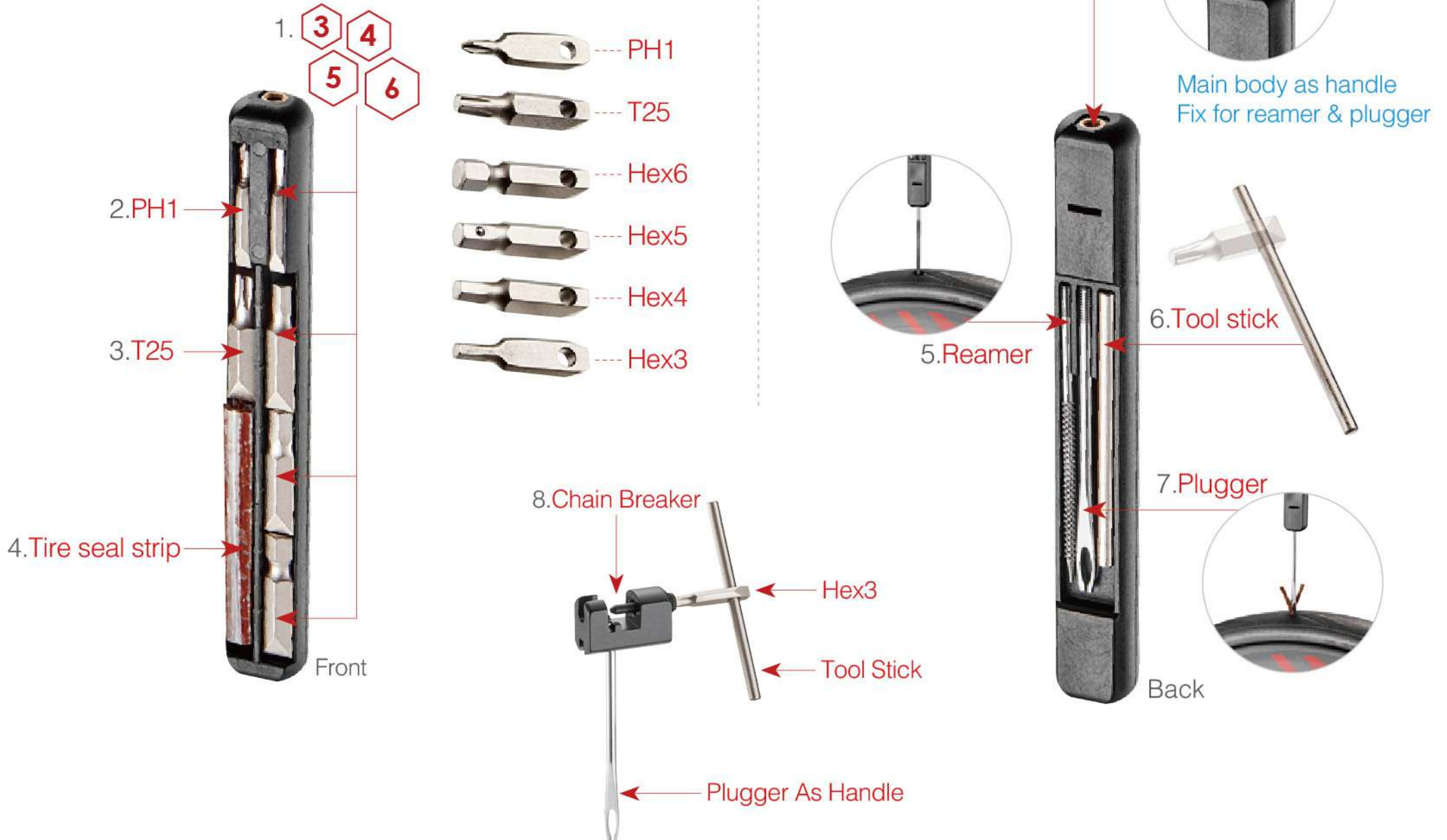

3 4 5 6
6功能板手組 6 PCS BITS

- 把手
Tool stick
- 十字
PH1
- 梅花25
T25
- 六角3
Hex3
- 六角4
Hex4
- 六角5
Hex5
- 六角6
Hex6

鏈條配件 LINKS & ACCESSORIES

- 快扣
Chain quick links
可自行到商店購買
(You may purchase it in the shop)
- 快扣拆卸
Chain Pliers
- 快扣存放槽
Master Links Storage
- 鏈條鉤
Bike Chain Hook
- 打鏈器
Chain Breaker

補胎和配件 PATCHING TIRE & ACCESSORIES

- Co2鋼瓶
Threaded CO2 cartridges
可自行到商店購買
(You may purchase it in the shop)
 - Co2氣瓶嘴(選配)
CO2 Inflator (Option)
 - (短)打氣筒(選配)
(S) Bicycle Pump (Option)
 - (長)打氣筒(選配)
(L) Bicycle Pump (Option)
 - (長)打氣筒轉接頭(選配)
(L) Bicycle Pump Adapter (Option)
- FOURIERS 選配配件**
(FOURIERS Option Accessories)

輪框配件 RIM SET ACCESSORIES

- 補胎片專用膠
Glue
可自行到商店購買
(You may purchase it in the shop)
- 磨片
Grinder
- 補胎片
Patch
- 自黏式補胎片
Self-adhesive patch
- 銼刀
Reamer
- 補胎條
Tire seal strip
- 補胎條壓入器
Plugger As Handle

- 輻條扳手
Spoke wrench
- 氣芯拆卸孔
Valve Core Tool
- 挖胎棒
Tire Lever
- 銅頭
Nipple
- 輻條
Spoke
可自行到商店購買
(You may purchase it in the shop)

22
Functions

建議在您旅行前從商店購買
SUGGEST BUY FROM SHOP BEFORE YOUR TRAVEL



輻條
Spoke



銅頭
Nipple



快扣
Chain quick links



補胎片
專用膠
Glue



Co2鋼瓶
Threaded
CO2 cartridges



TL-500 / Weight: 128g / **14 Functions**
 (TL-500-1+TL-101-1+TL-102-1)



Compatible with the CO2 Cartridge or the
 ADP-CO2-A1-T (optional).



TL-600 / Weight: 179.5g / **15 Functions**
 (TL-101+TL-102)

TL-700 / Weight: 224g / 15 Functions
 (TL-101+TL-102+WB-UHD-22)



TL-750 / Weight: 224g / 15 Functions
 (TL-500-1+TL-101+TL-102+WB-UHD-22)



TL-800 / Weight: 367g / 17 Functions

(Bicycle Pump+TL-103+ADP-CO2-A1-T+ADP-CO2-A1-C+WB-UHD-22)



Compatible with the CO2 Cartridge or the
ADP-CO2-A1-T / ADP-CO2-A1-C.

ADP-CO2-A1-C



P.A.T.E.D



Front



Back



TL-801 / Weight: 367g / **17 Functions**
(WB-UHD-22+Bicycle Pump+TL-103)



Compatible with the CO2 Cartridge or the
ADP-CO2-A1-T / ADP-CO2-A1-C (optional).



TL-105

Stainless steel plate nylon container

CONTENT: Spoke wrench x 1pcs
Patch x 12pcs
Tire seal strip 5 strip x 5pack
Self-adhesive patch x 12pcs
Grinder x 1pcs





F-STRAP

Quick and easy to carry repair kits when long distance riding.

VELCRO LENGTH: 58cm

Tools not included



F-STRAP-BAG

Quick and easy to carry repair kits when long distance riding, include mounting bag to help for sorting kit.

VELCRO LENGTH: 58cm

Tools not included



FITTING

Series



NEW

ADP-FIT-WR

Quick and easy to change position for trainer or fitting.
Angle adjustment from 0 to 12 degrees.
Four wheels allow it to adjust itself.



ADP-FIT-E220

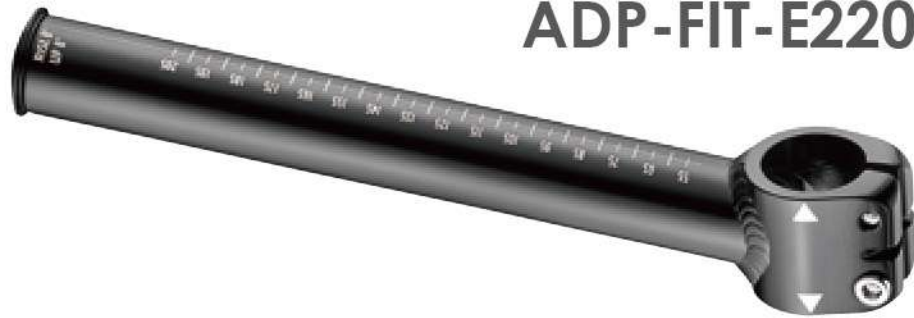

Adjustable welding stem.

MATERIAL: AL6066

ANGLE: $\pm 8^\circ$

CLAMP HEIGHT: 50mm

C-C: 205mm

STEM TUBE SIZE: $\varnothing 28.6\text{m}$

Length adjustable 55mm~205mm

Only for fitting setting not for outdoor riding.



ADP-FIT-RHB



Allow you to find the most appropriate handlebar width swiftly and painlessly.

Ease your physical fatigue for long distance riding.

MATERIAL: AL6061

SPEC: 320~440mm

DROP: ± 125 mm

REACH: ± 70 mm

Only for fitting setting not for outdoor riding.

Find your perfect handlebar width swiftly.





ADP-FIT-SA

Use the **STEM ADJUSTER** to provide fitting service for the biker on his or her own bike to earn the right stem length (50mm~150mm) and angle (± 30 degrees) .

FORK STACK HIGH: $\varnothing 40\text{mm}$, $\varnothing 31.8\text{mm}$ with shim $\varnothing 28.6\text{mm}$

HANDLEBAR CLAMP: $\varnothing 35\text{mm}$ with shim $\varnothing 31.8\text{mm}$

LENGTH: 50 - 150mm

ANGLE: $\pm 30^\circ$



ADP-FIT-XYA



Stem dimension inspection platform.

MATERIAL: AL6061-T6

SPEC:

HANDLEBAR STEM: $\text{Ø}31.8 \times \text{Ø}34.9 \times (\text{H})50\text{mm} \times 1\text{pc}$

SPACER: $\text{IDØ}28.6 \times \text{ODØ}34.2 \times (\text{H})3\text{mm} \times 2\text{pcs}$

$\text{IDØ}28.6 \times \text{ODØ}34.2 \times (\text{H})5\text{mm} \times 2\text{pcs}$

$\text{IDØ}28.6 \times \text{ODØ}34.2 \times (\text{H})10\text{mm} \times 1\text{pc}$

$\text{IDØ}31.8 \times \text{ODØ}38.8 \times (\text{H})2.5\text{mm} \times 2\text{pcs}$

$\text{IDØ}31.8 \times \text{ODØ}38.8 \times (\text{H})5\text{mm} \times 2\text{pcs}$

$\text{IDØ}31.8 \times \text{ODØ}38.8 \times (\text{H})10\text{mm} \times 1\text{pc}$

SHIM-CC-AL: $\text{IDØ}28.6 \times \text{ODØ}31.8 \times (\text{H})38\text{mm} \times 1\text{pc}$

$\text{IDØ}31.8 \times \text{ODØ}34.9 \times (\text{H})58\text{mm} \times 1\text{pc}$

WEIGHT: 2.515kg/set



ADP-FIT-CZ

Precision CNC machines fitting bike sizing cranks.

CRANK LENGTH: 145,150,155,160,165,167.5,170,
172.5,175,177.5,180mm

AXLE: 24mm / 30mm

MATERIAL: Crank: AL6061-T6
Axle: AL7075-T651

CHAINRING: Single 46T



CK-GRA



145 147.5 150 152.5 155 157.5 160 162.5 165 167.5 170 172.5 175mm